

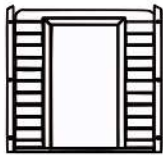











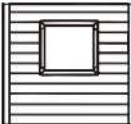

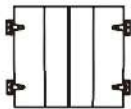
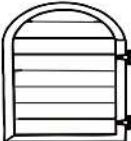







UDIM

1		1
2		1
3		2
4		2
5		2
6		2
7		2
8		1
9		1
10		1
11		2
12		1
13		4

A		Ø3.0*22	16
B		Ø3.0*28	14
C		Ø3.0*25	6
D		Ø3.5*30	8
E		Ø3.5*40	1
F		Ø3.5*50	12
G		Ø3.5*24	8
H		Ø3.0*16	30
I			4
J			8
K	 lišta 13 mm		

1

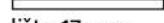
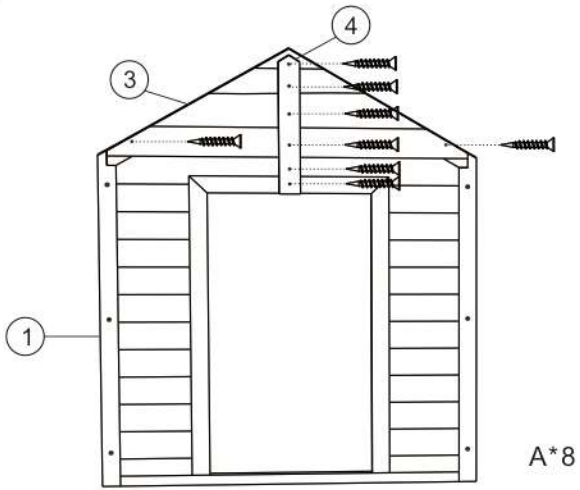

Vyrovnejte část 4 so spodnou hranou rámu dverí.

2

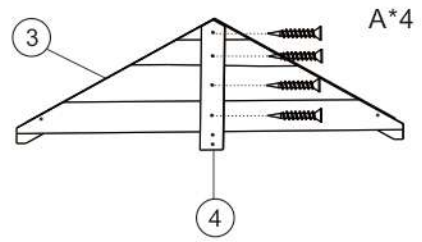

3

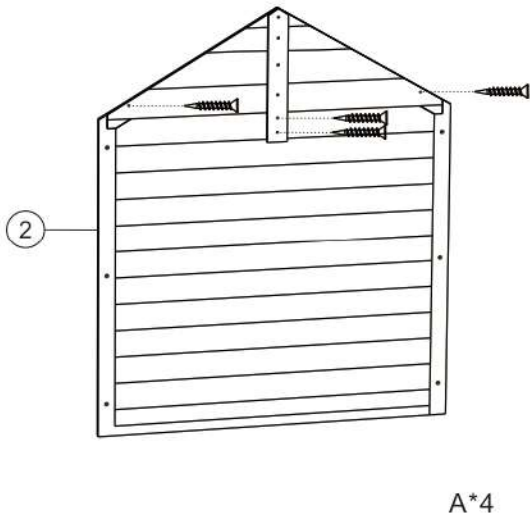

4

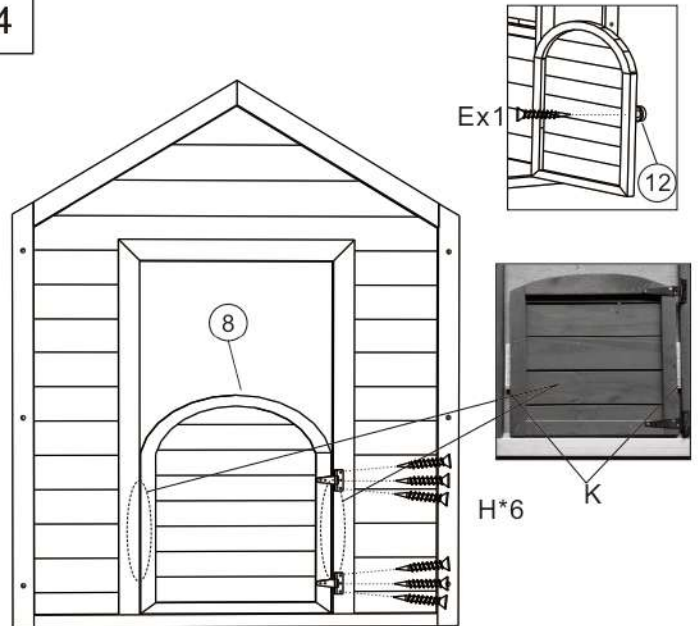

Pri montáži dverí a okna sa uistite, že ste nechali 13 mm medzeru.

5

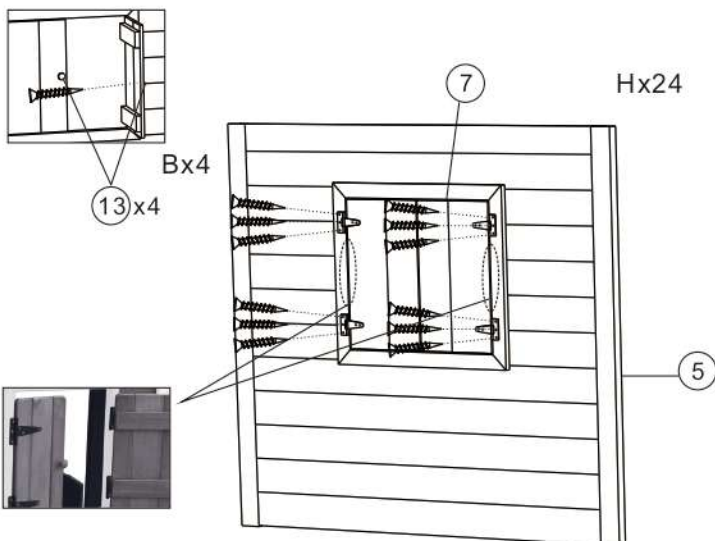

Pri montáži dverí a okna sa uistite, že ste nechali 13 mm medzeru.

6

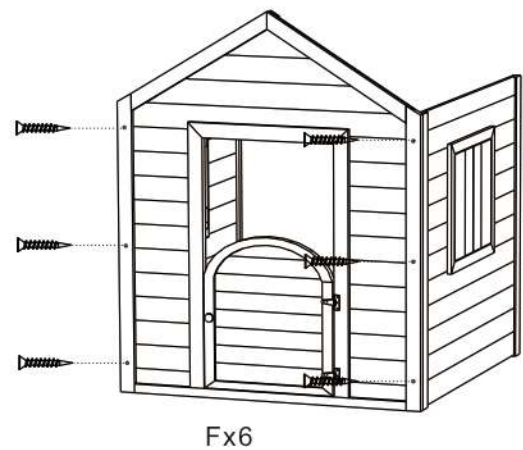

7

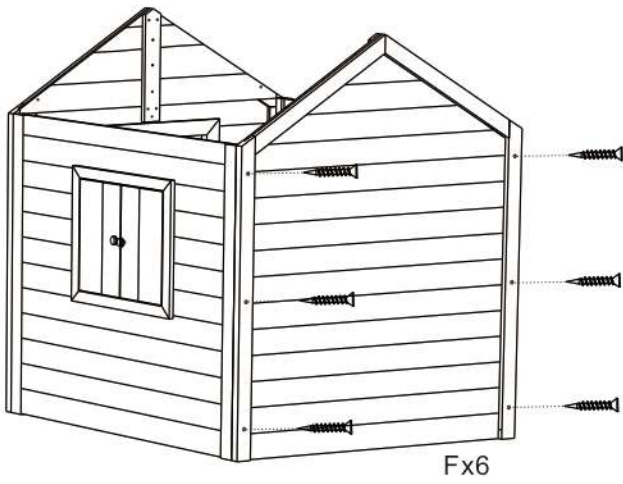

8

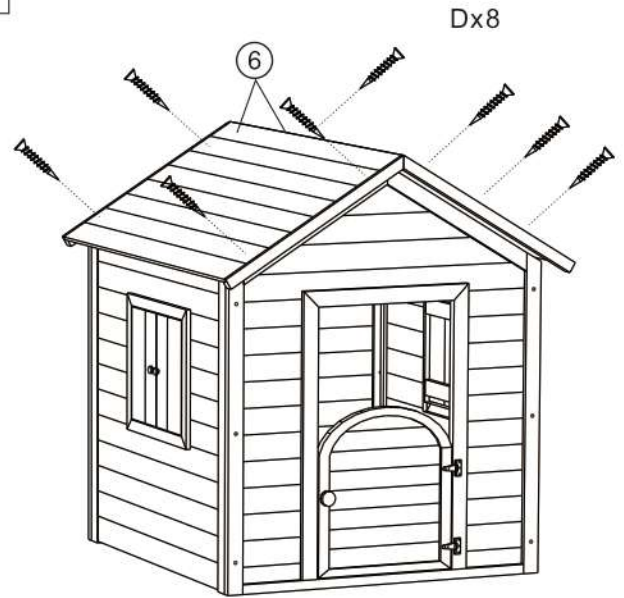

9

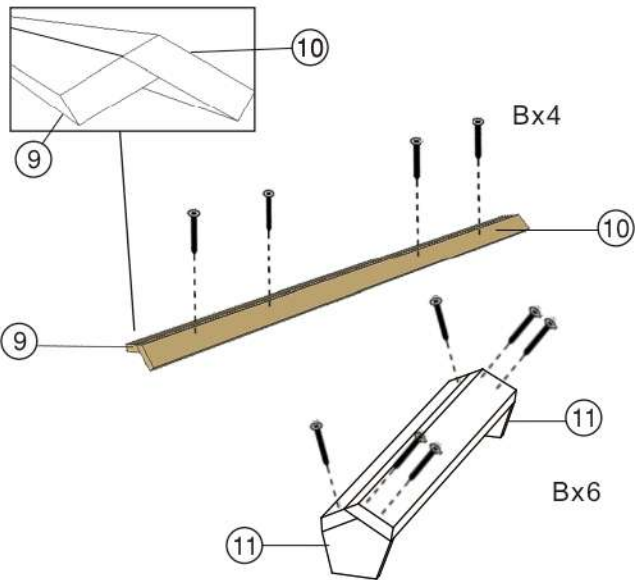

10

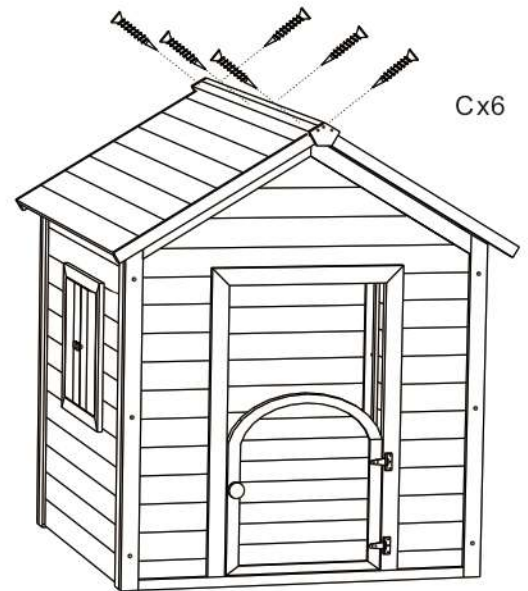

11

